

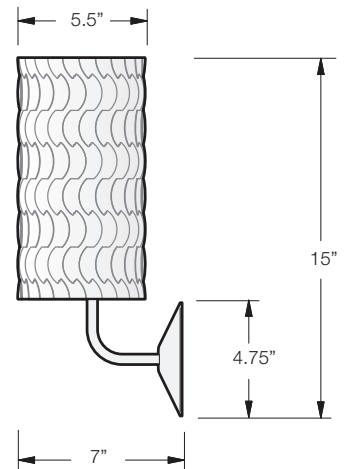







dform | small pucci wall lamp



model	shade material	lampholder type	voltage	metal finish
WS24			120	
size 5.5" W x 15" H x 7" D	standard A =  aspen B =  birch	A = (1) 60w incandescent A19 also compatible with fluorescent screw base lamps are not included	 120 only	M1=  silver metallic
weight 2 lbs				
certification 	custom P =  white poly additional charges apply to custom options	G = (1) 26w fluoresent GU24 twist lock		M2=  light bronze M3=  dark bronze

material details

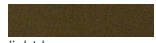
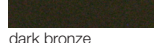
mounting details

project:

type:

quantity:

notes:

shade

the standard shade material is 2-ply wood veneer with a poly core lamination and surface coating. The material is cleanable with soap water and cloth or household spray cleaners.

the custom white poly material can also be made in other colors.

hardware

all hardware is steel or aluminum with a powder coat finish.

